

Modular throttle valves type SHQ, SKQ

flow control, ISO 4401 sizes 06 and 10

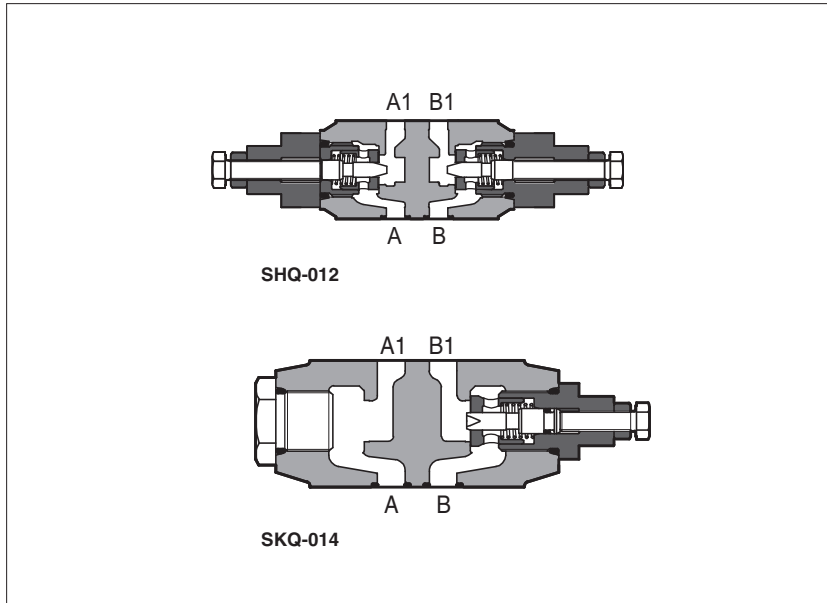

SHQ and **SKQ** are flow throttling valves, not compensated, and with check valve to allow free reverse flow. The flow adjustment is performed by turning the setting screw. Clockwise rotation increases the throttling (passage reduced).

Valve size and max flow:

SHQ-0 = size 06, flow up to 80 l/min

SKQ-0 = size 10, flow up to 160 l/min

Mounting surface:

ISO 4401 size 06 and 10

Max pressure: **350 bar** (SHQ)
315 bar (SKQ)

1 MODEL CODE

SHQ-0	13	**	/	*
Modular flow control valve, size: SHQ-0 = 06 SKQ-0 = 10				
Configuration, see section 2 meter OUT control: 12 = double, acting on port A and B 13 = single, acting on port A 14 = single, acting on port B		meter IN control: 22 = double, acting on port A and B 23 = single, acting on port A 24 = single, acting on port B		
		Seals material, see section 3: - = NBR PE = FKM BT = HNBR		
		Series number		

2 VALVE CONFIGURATION

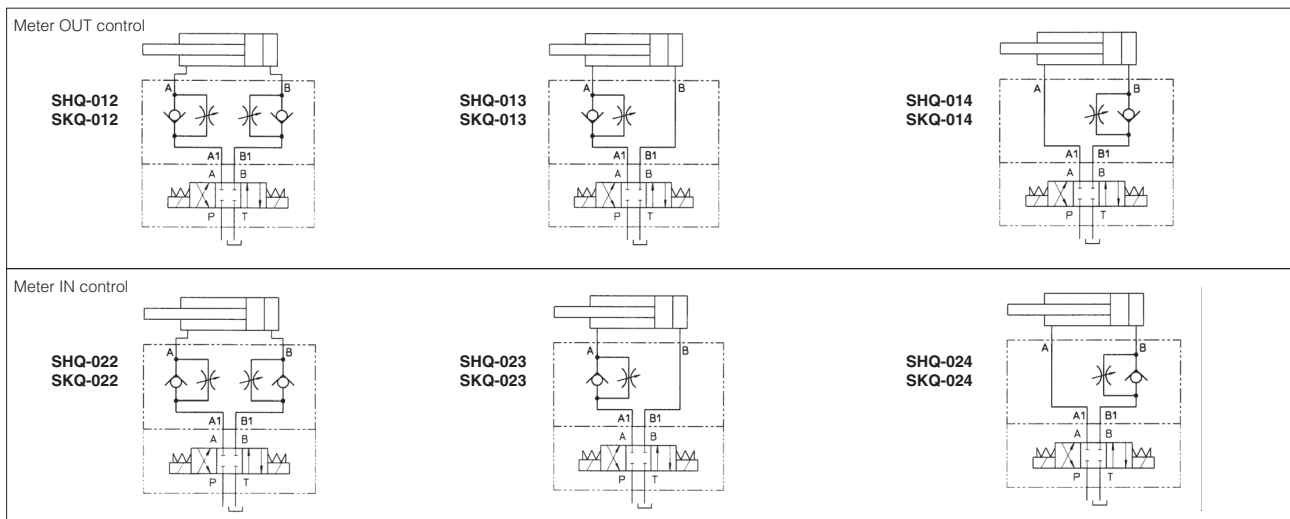

3 MAIN CHARACTERISTICS, SEALS and HYDRAULIC FLUID - for other fluids not included in below table, consult our technical office

Assembly position / location	Any position		
Subplate surface finishing	Roughness index Ra 0,4 - flatness ratio 0,01/100 (ISO 1101)		
MTTFd values according to EN ISO 13849	150 years, for further details see technical table P007		
Ambient temperature	Standard execution = -30°C ÷ +70°C /PE option = -20°C ÷ +70°C /BT option = -40°C ÷ +70°C		
Seals, recommended fluid temperature	NBR seals (standard) = -20°C ÷ +80°C, with HFC hydraulic fluids = -20°C ÷ +50°C FKM seals (/PE option) = -20°C ÷ +80°C HNBR seals (/BT option) = -40°C ÷ +60°C, with HFC hydraulic fluids = -40°C ÷ +50°C		
Recommended viscosity	15 ÷ 100 mm ² /s - max allowed range 2.8 ÷ 500 mm ² /s		
Max fluid contamination level	ISO4406 class 20/18/15 NAS1638 class 9, see also filter section at www.atos.com or KTF catalog		
Hydraulic fluid	Suitable seals type	Classification	Ref. Standard
Mineral oils	NBR, FKM, HNBR	HL, HLP, HLPD, HVLP, HVLPD	DIN 51524
Flame resistant without water	FKM	HFDU, HFDR	ISO 12922
Flame resistant with water	NBR, HNBR	HFC	

4 DIAGRAMS OF SHQ-0 based on mineral oil ISO VG 46 at 50°C

- 1 = Regulation diagram at Δp 10 bar
- 2 = Regulation diagram at Δp 30 bar
- 3 = Regulation diagram at Δp 50 bar
- 4 = Q/Δp diagram for free flow through the non-return valve

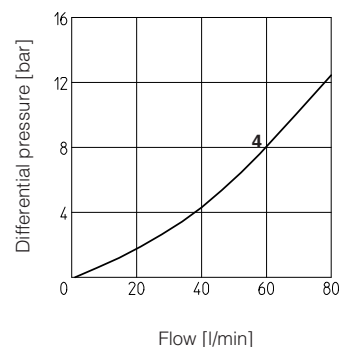
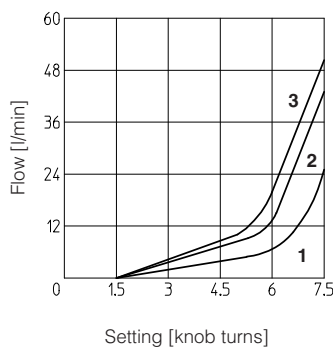

5 DIAGRAMS OF SKQ-0 based on mineral oil ISO VG 46 at 50°C

- 1 = Regulation diagram at Δp 10 bar
- 2 = Regulation diagram at Δp 30 bar
- 3 = Regulation diagram at Δp 50 bar
- 4 = Q/Δp diagram for free flow through the non-return valve

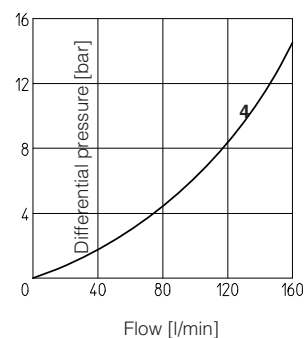
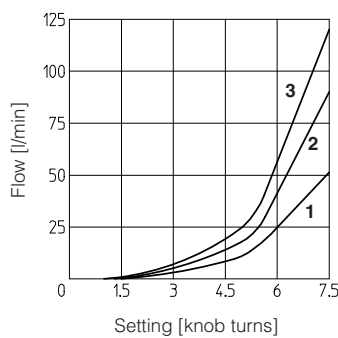

6 INSTALLATION DIMENSIONS OF SHQ-0 VALVES [mm]

SHQ-012
SHQ-022

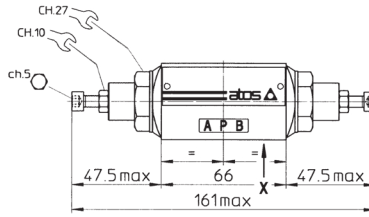
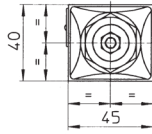

Mass: 1,1 Kg

SHQ-013
SHQ-014
SHQ-023
SHQ-024

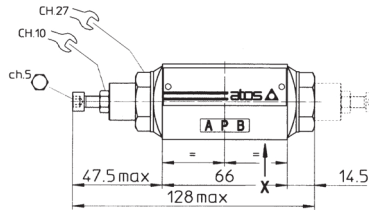
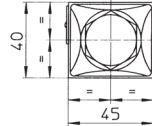

In version -014 and -024 the regulating element is on side of port B (dotted line) instead of side of port A.

Mass: 1,2 Kg

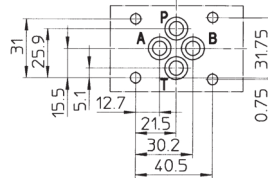

ISO 4401: 2005

Mounting surface: 4401-03-02-0-05

Diameter of ports A, B, P, T: $\varnothing = 7,5$ mm (max)

Seals: 4 OR 108

Fastening bolts: n° 4 socket head screws M5. The length depends on number and type of modular elements associated.

7 INSTALLATION DIMENSIONS OF SKQ-0 VALVES [mm]

SKQ-012
SKQ-022

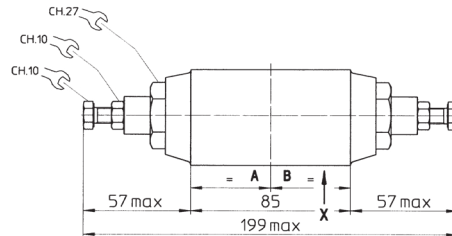
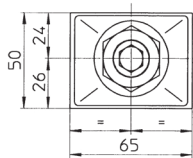

Mass: 2 Kg

SKQ-013
SKQ-014
SKQ-023
SKQ-024

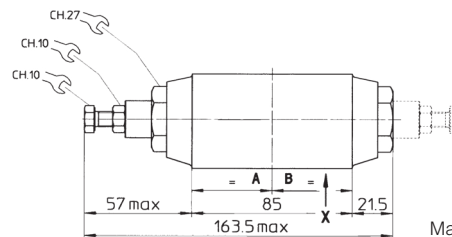
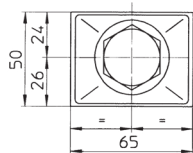

In version -014 and -024 the regulating element is on side of port B (dotted line) instead of side of port A.

Mass: 2,2 Kg

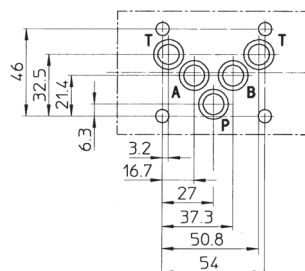

ISO 4401: 2005

Mounting surface: 4401-05-04-0-05

Diameter of ports, A, B, P, T: $\varnothing = 11,2$ mm (max)

Seals: 5 OR 2050

Fastening bolts: n° 4 socket head screws M6. The length depends on number and type of modular elements associated.